

JVC

SCHEMATIC DIAGRAMS

COMPACT COMPONENT SYSTEM

FS-P550

CD-ROM No.SML200405

Area suffix

C ----- Canada

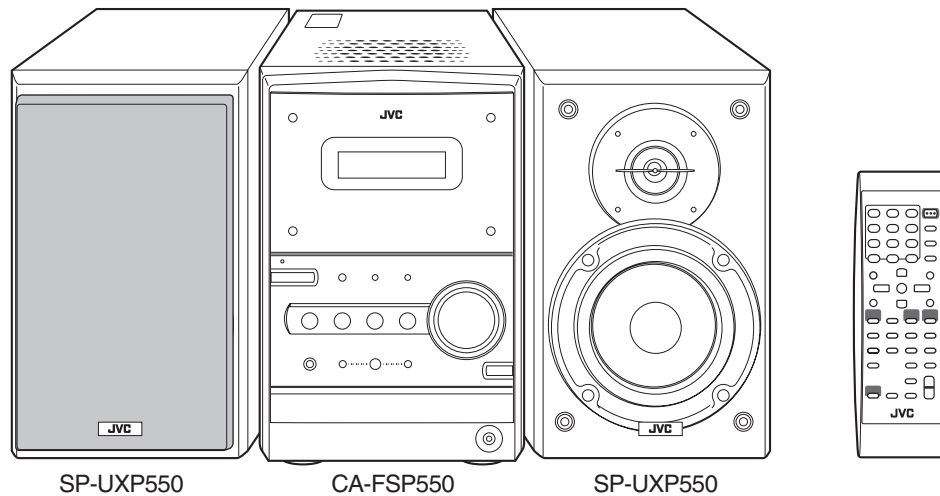

SP-UXP550

CA-FSP550

SP-UXP550



AV COMPU LINK

Contents

Block diagram	2-1
Standard schematic diagrams	2-2
Printed circuit boards	2-9 to 11

In regard with component parts appearing on the silk-screen printed side (parts side) of the PWB diagrams, the parts that are printed over with black such as the resistor (■), diode (⬤) and ICP (●) or identified by the "▲" mark nearby are critical for safety.

(This regulation does not correspond to J and C version.)

Block diagram

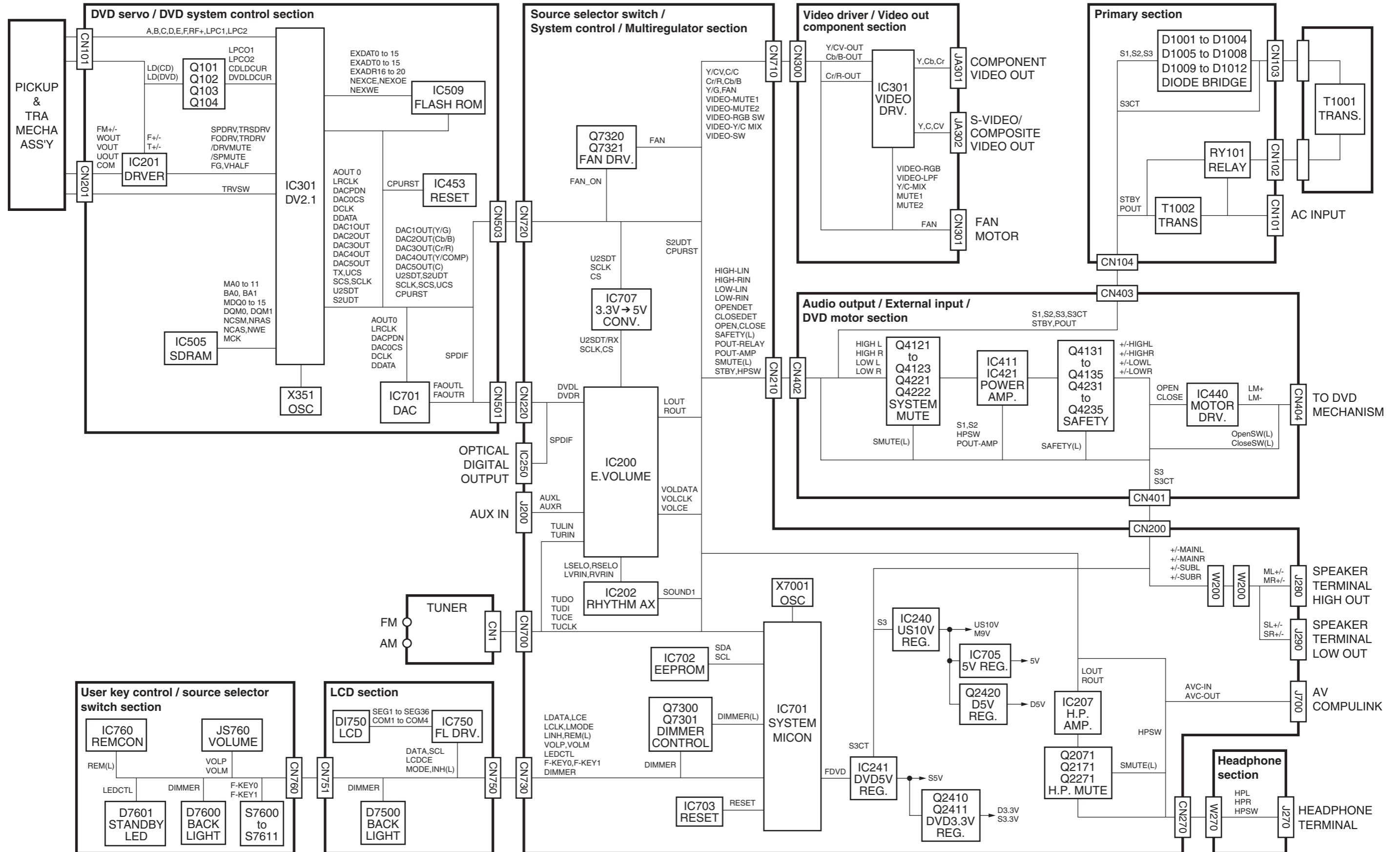

Standard schematic diagrams

■ Primary with mains transformer section

EXPLANATION OF OVERALL OF SCHEMATIC		
MODEL : FS-P550/UX-P550		
SHEET NUMBER	MODEL NUMBERS TO BE APPLIED	CIRCUITS DESCRIPTION
1	FS-P550/UX-P550	PRIMARY WITH MAINS TRANSFORMER
2	FS-P550/UX-P550	AUDIO OUTPUT/EXTERNAL INPUT DVD MOTOR
3	FS-P550/UX-P550	MULTIREGULATOR/LPF/RHYTHM AX
4	FS-P550/UX-P550	SOURCE SELECTOR SWITCH LCD DISPLAY/SYSTEM CONTROL/USERS KEY CONTROL
5	FS-P550/UX-P550	VIDEO DRIVER/VIDEO OUT COMPONENT
6	FS-P550/UX-P550	DVD SERVO AND DVD SYSTEM CONTROL 1/2
7	FS-P550/UX-P550	DVD SERVO AND DVD SYSTEM CONTROL 2/2

*NOTE : MARK () IS TO SHOW DEVIATION IN VERSIONS.
DETAILS ARE EXPLAINED NEAR MARK.

VERSION CODES

C : CANADA
B : U.K
E : CONTINENTAL EUROPE
EN : NORDIC COUNTRIES
EV : EASTERN EUROPE
UX : SAUDI ARABIA
UF : CHINA
UW : SOUTH AMERICA
UJ : US ARMY
EE : RUSSIA
UB : HONG KONG
UN : INDONESIA
US : SINGAPORE AND UNIVERSAL
EXCEPT ALL OF ABOVE

NOTES

- VOLTAGES ARE MEASURED USING A DIGITAL VOLTMETER OR AN OSCILLOSCOPE WITHOUT INPUT SIGNAL IN CD STOP MODE CONDITION UNLESS OTHERWISE SPECIFIED
- ALL RESISTORS ARE 1/4W 5% CARBON RESISTOR.
ALL CAPACITORS ARE 50V CERAMIC CAPACITOR OR 50V MYLAR CAPACITOR UNLESS OTHERWISE SPECIFIED.
ALL RESISTANCE VALUES ARE IN OHM(Ω).
ALL CAPACITANCE VALUES ARE IN PICO(FP).
ALL E-CAPACITORS ARE SHOWN IN THE FORM OF CAPACITANCE(μF)/RATED VOLTAGE (V).
ALL DIODES ARE 1N5119/541-T2 TYPE UNLESS SPECIFIED.
POLYPROPYLENE CAPACITOR
50V 5% MYLAR CAPACITOR OR 50V 5% 35MM FILM CAPACITOR

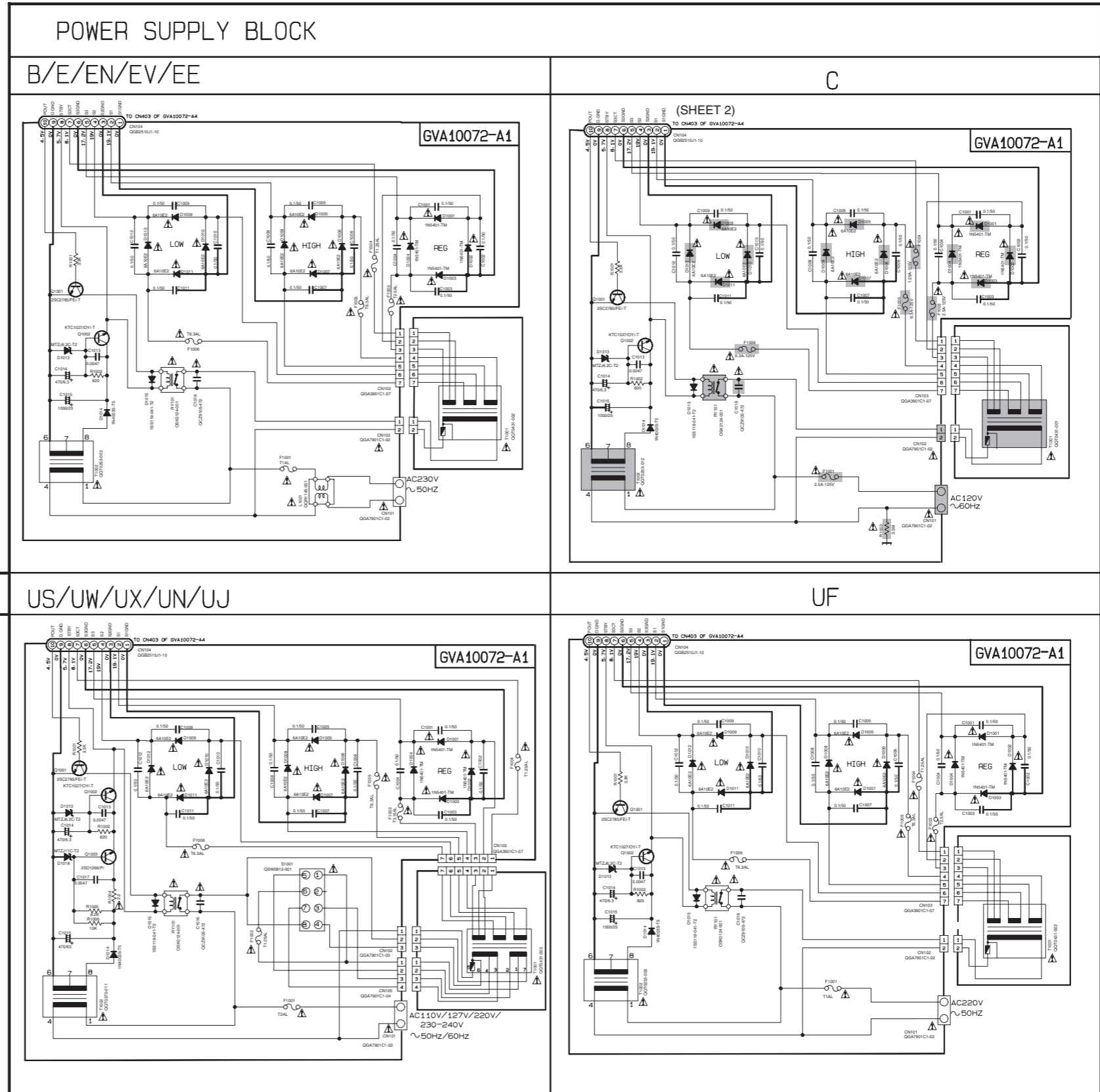

VOLTAGE SELECTOR LOCATION

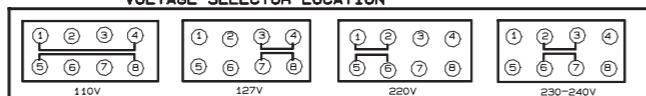

▲ Parts are safety assurance parts.
When replacing those parts make sure to use the specified one.

■ Audio output / External input / DVD motor section

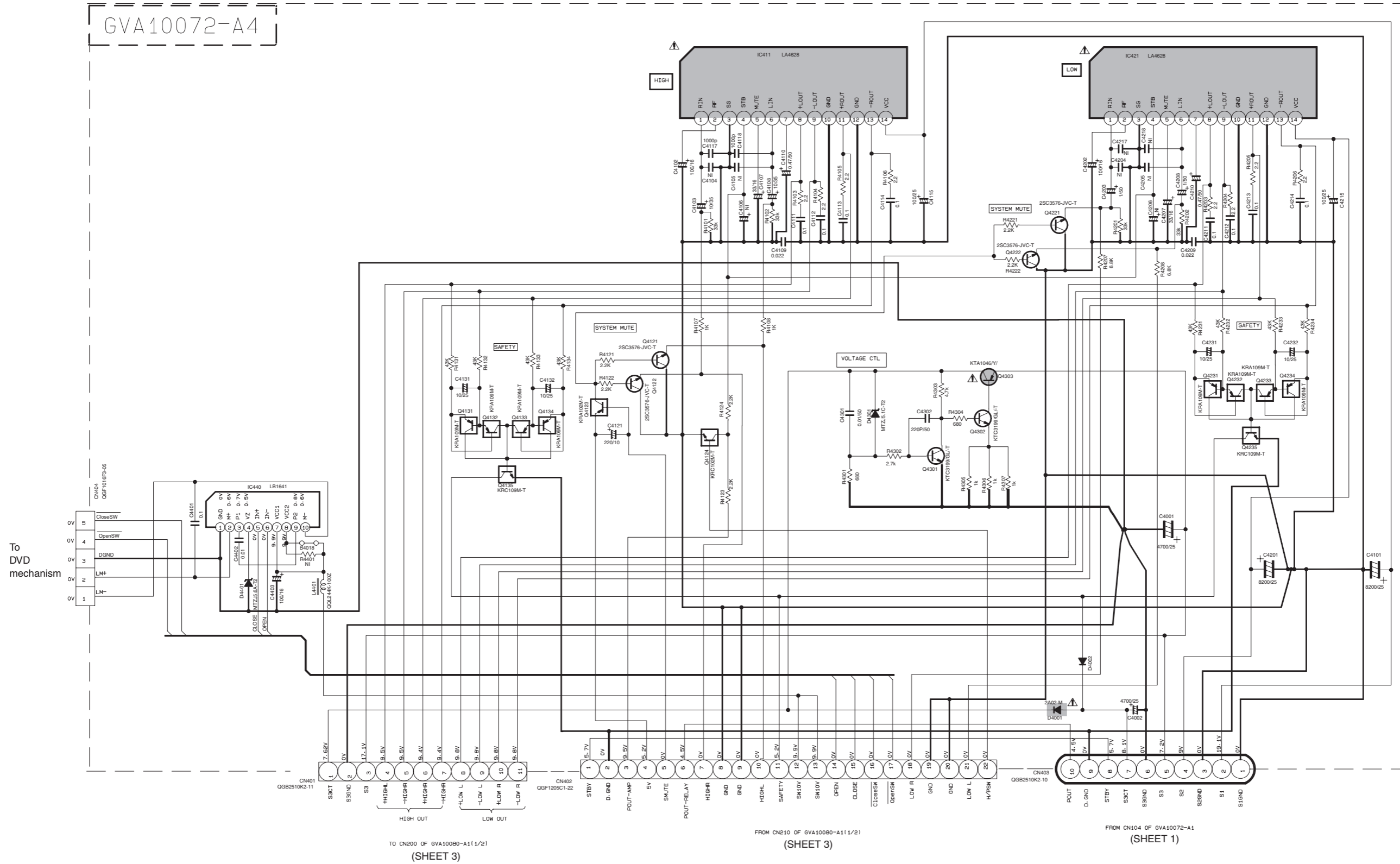

⚠ Parts are safety assurance parts. When replacing those parts make sure to use the specified one.

- NOTES
- VOLTAGES ARE DC-MEASURED USING A DIGITAL VOLTMETER OR AN OSCILLOSCOPE WITHOUT INPUT SIGNAL IN CD STOP MODE CONDITION UNLESS OTHERWISE SPECIFIED.
 - ALL RESISTORS ARE 1/8W 5% CARBON RESISTOR. ALL CAPACITORS ARE 50V CERAMIC CAPACITOR OR 50V MYLAR CAPACITOR. ALL RESISTANCE VALUES ARE IN OHM(Ω). ALL CAPACITANCE VALUES ARE IN nF(pF). ALL E-CAPACITORS ARE SHOWN IN THE FORM OF CAPACITANCE(μF)/RATED VOLTAGE (V). ALL DIODES ARE 1SS119-041-T2 TYPE UNLESS SPECIFIED.
- POLYPROPYLENE CAPACITOR
50V ±5% MYLAR CAPACITOR OR 50V 5% 1/4IN FILM CAPACITOR

■ Multiregulator / LPF / PHYTHM AX section

(SHEET 2)
FROM CN401 OF
GVA10072-A4

(SHEET 7)
TO CN501 OF LVA10452-211B

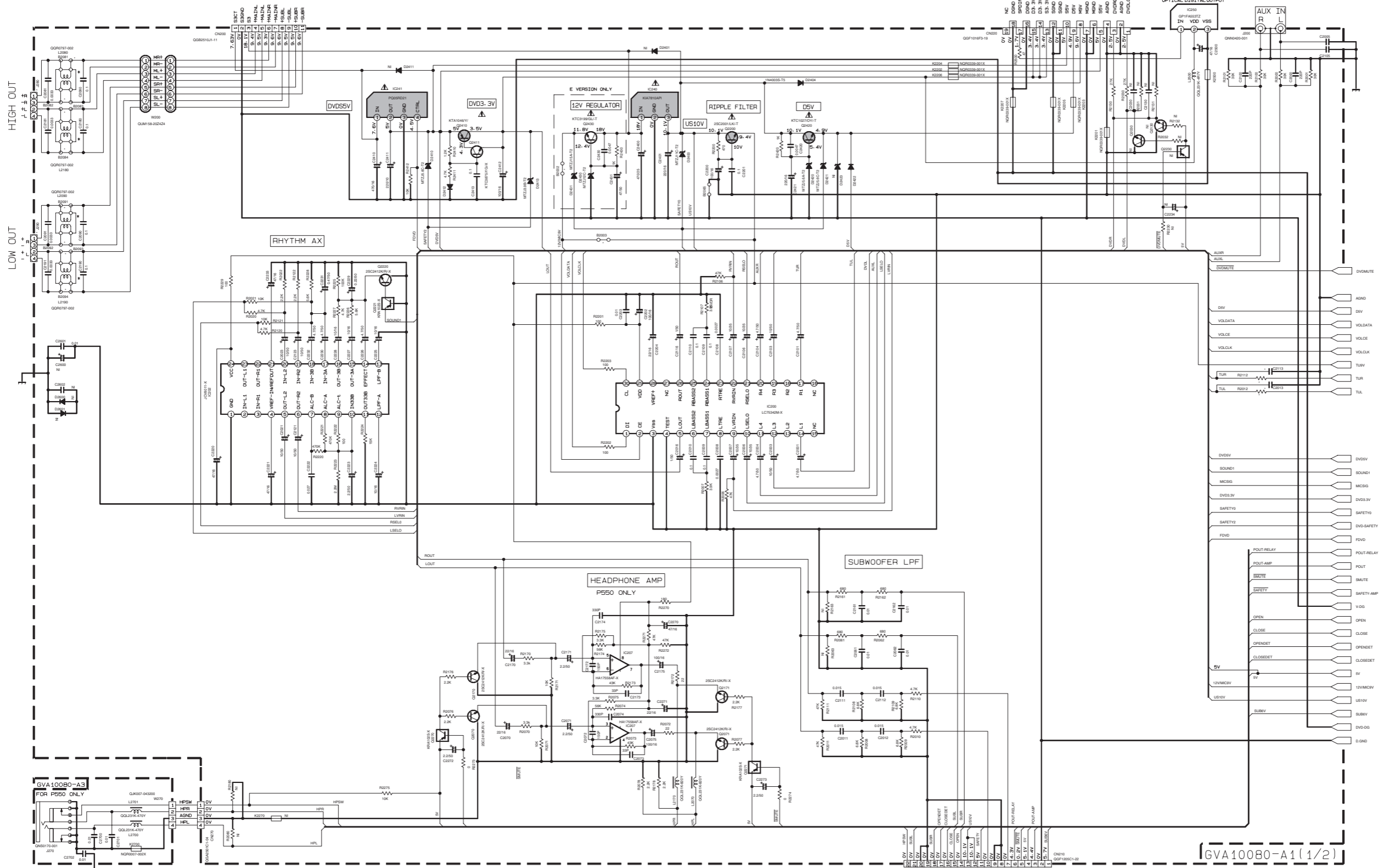

NOTES
1. VOLTAGES ARE DC-MEASURED WITH A DIGITAL VOLT METER OR OSCILLOSCOPE WITHOUT INPUT SIGNAL. CONDITION --- CD STOP MODE
2. UNLESS OTHERWISE SPECIFIED:
ALL RESISTORS ARE 1/4W ± 5% CARBON FILM RESISTOR OR 0.063W ± 5% THICK FILM CHIP RESISTOR
ALL CAPACITORS ARE CERAMIC CAPACITOR OR MYLAR CAPACITOR.
ALL RESISTANCE VALUES ARE IN OHM (Ω).
ALL CAPACITANCE VALUES ARE IN F(PpF).
ALL E-CAPACITORS ARE SHOWN IN THE FORM OF CAPACITANCE (F) RATED VOLTAGE (V).
ALL INDUCTANCE VALUES ARE IN μH(MH).
ALL DIODES ARE 1SS149-041-T2
ALL FERRITE BEADS ARE GQR0621-001Z

* REMARKS

	B/E/EN/EE	C	UF
B2002	USE	-	-
B2003	-	-	-
L2080/L2180 L2090/L2190	USE	-	USE
B2081-B2084 B2091-B2094	-	USE	-
J280	QNB0172-001	QNB0172-002	QNB0172-001
J290	QNB0038-001	QNB0194-001	QNB0038-001
R2012/R2112	1K	20K	20K
C2013/C2113	4700p	560p	560p

TO CN402 OF GVA10072-A4
(SHEET 2)

▲ Parts are safety assurance parts.
When replacing those parts make sure to use the specified one.

(SHEET 4)

■ Source selector switch / LCD display / System control / Users key control section

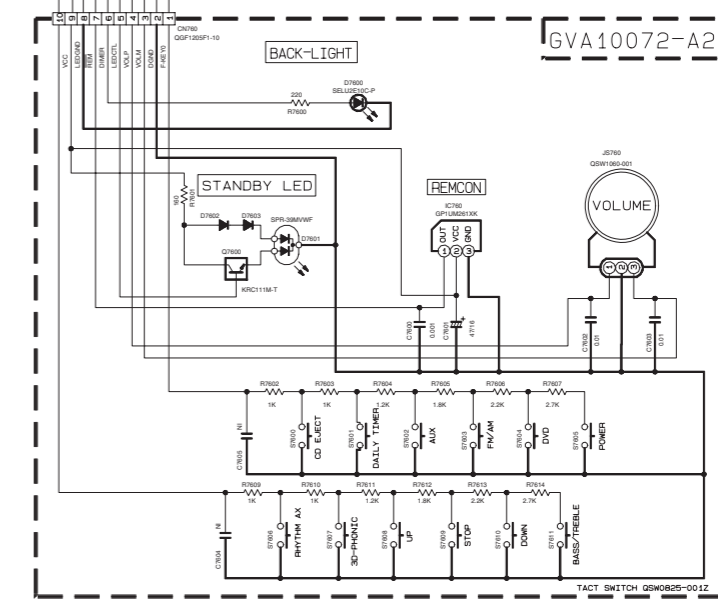
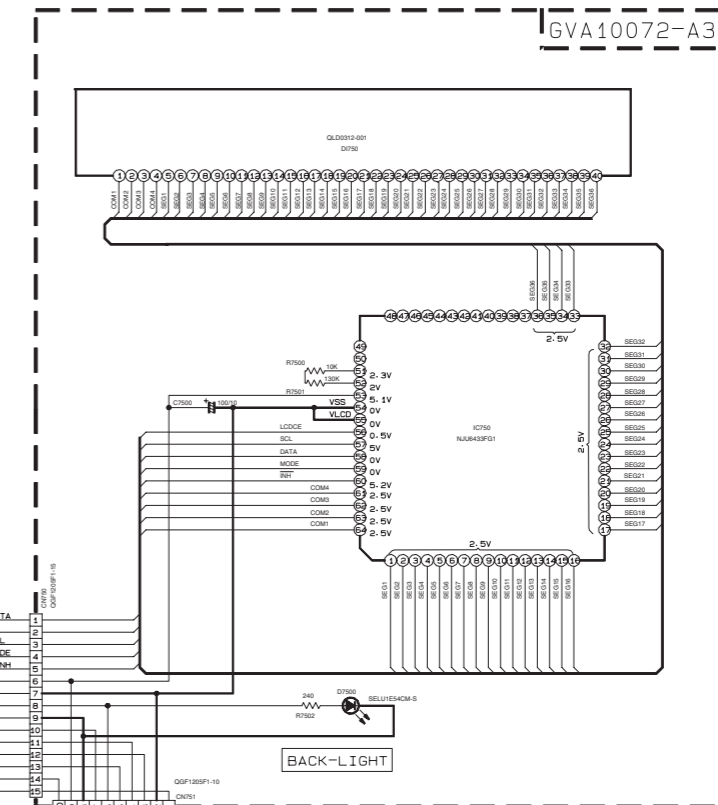
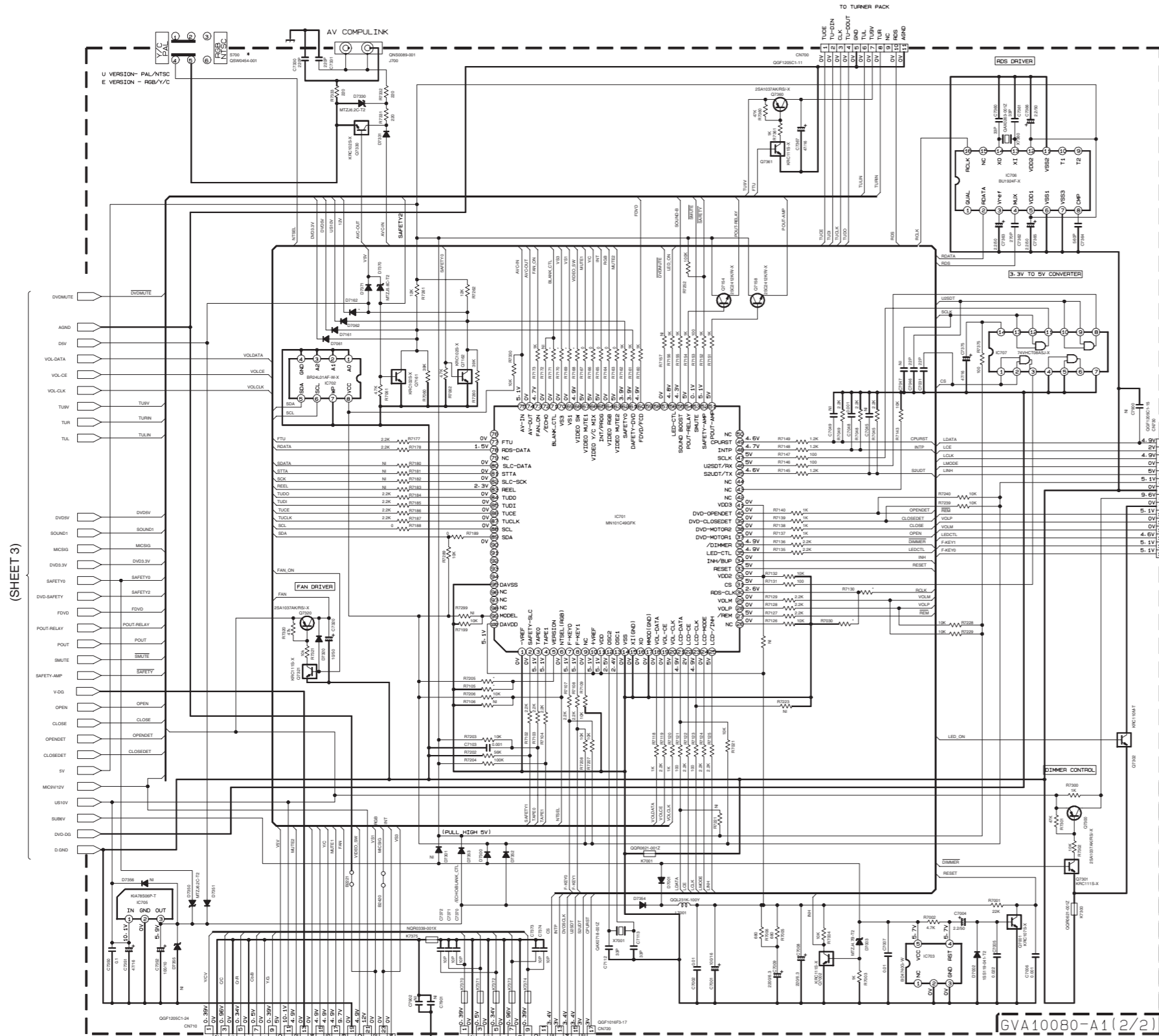

* REMARKS

R	B/E	EN/VE/EE	C	UF
R7105	10K	-	10K	-
R7205	82K	27K	3.3K	-
S700	USE	-	USE	-
D7162	USE	-	-	-
R7030	-	-	10K	10K
R7130	2.2K	-	-	-
R7158	0	-	-	-
R7169	0	-	-	-
R7170	0	-	-	-
R7171	0	-	-	-

NOTES

1. VOLTAGES ARE DC-MEASURED WITH A DIGITAL VOLT METER OR OSCILLOSCOPE WITHOUT INPUT SIGNAL. CONDITION — CD STOP MODE

2. UNLESS OTHERWISE SPECIFIED, ALL RESISTORS ARE 1/4W ± 5% CARBON FILM RESISTOR OR 0.063W ± 5% THICK FILM CHIP RESISTOR

ALL CAPACITORS ARE CERAMIC CAPACITOR OR MYLAR CAPACITOR.

ALL RESISTANCE VALUES ARE IN OHM (Ω). ALL CAPACITANCE VALUES ARE IN PICO-FARAD (pF). ALL E-CAPACITORS ARE SHOWN IN THE FORM OF CAPACITANCE (μF) / RATED VOLTAGE (V). ALL INDUCTANCE VALUES ARE IN MILLI-HENRY (mH). ALL DIODES ARE 1SS119-041-72

ALL FERRITE BEADS ARE NGR007-002X

Video driver / Video out component section

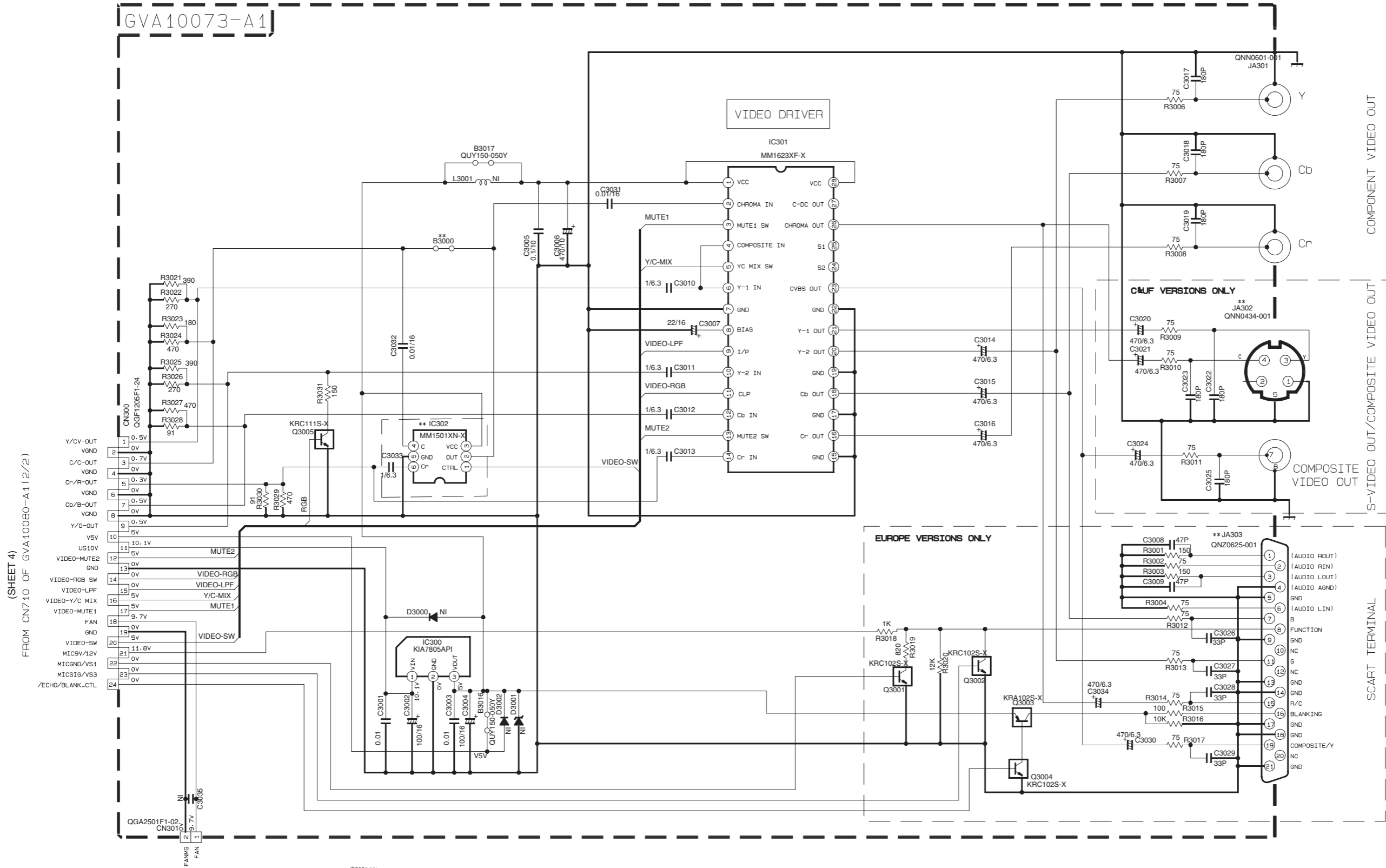

**Mark

	B/E/EN/EV/EE	C/UF
IC302	USE	-
B3000	-	USE
JA302	-	USE
JA303	USE	-

FROM CN710 OF GVA10080-A1 (2/2)

DVD servo and DVD system control section (1/2)

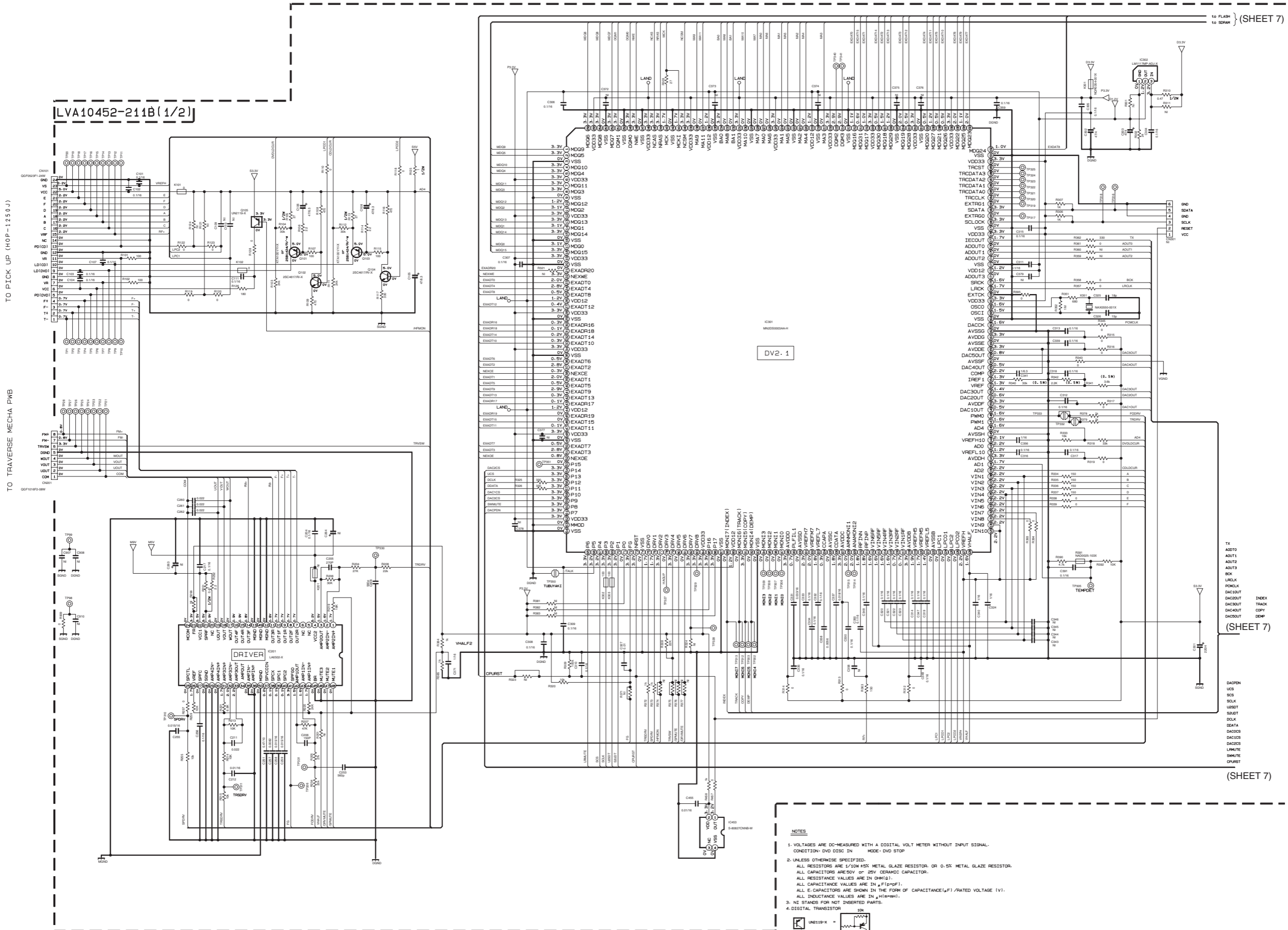

DVD servo and DVD system control section (2/2)

LVA10452-211B(2/2)

(SHEET 6)

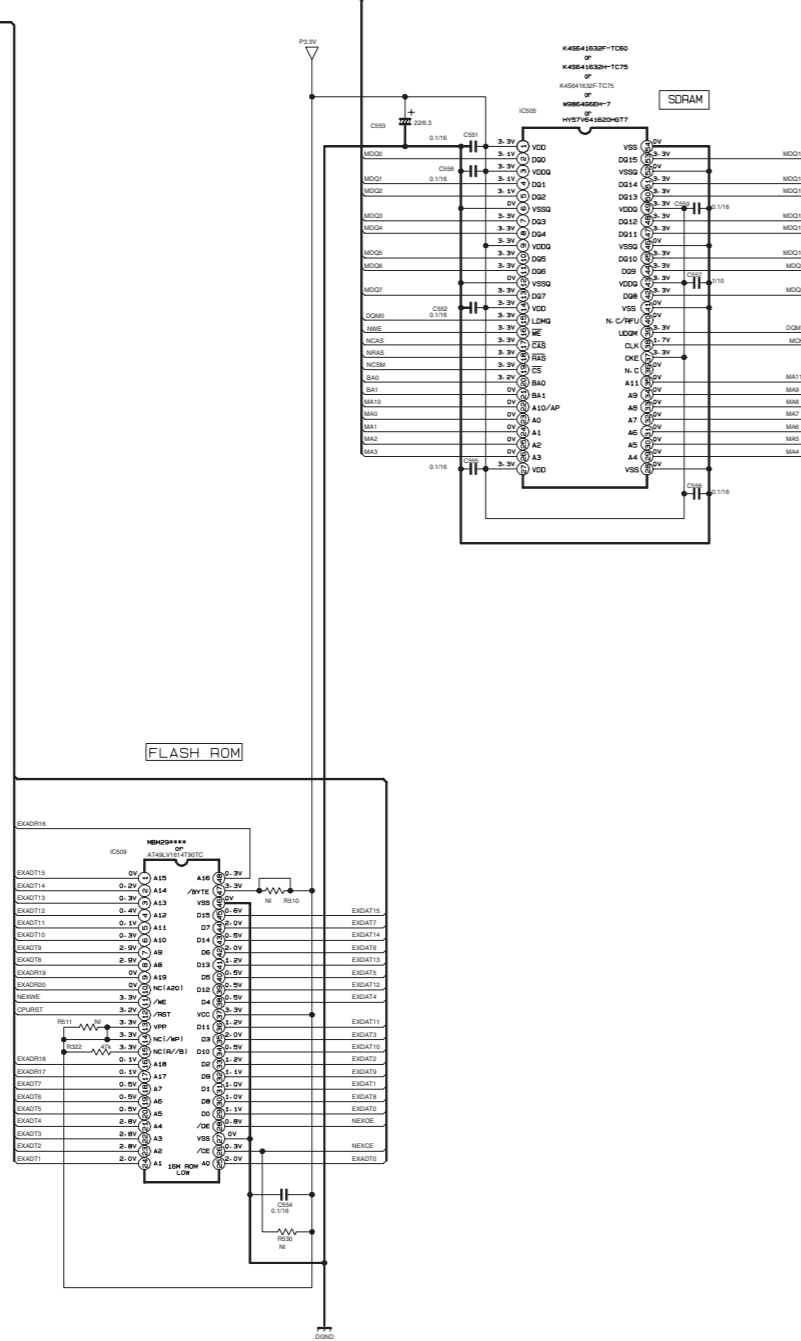

(SHEET 6)

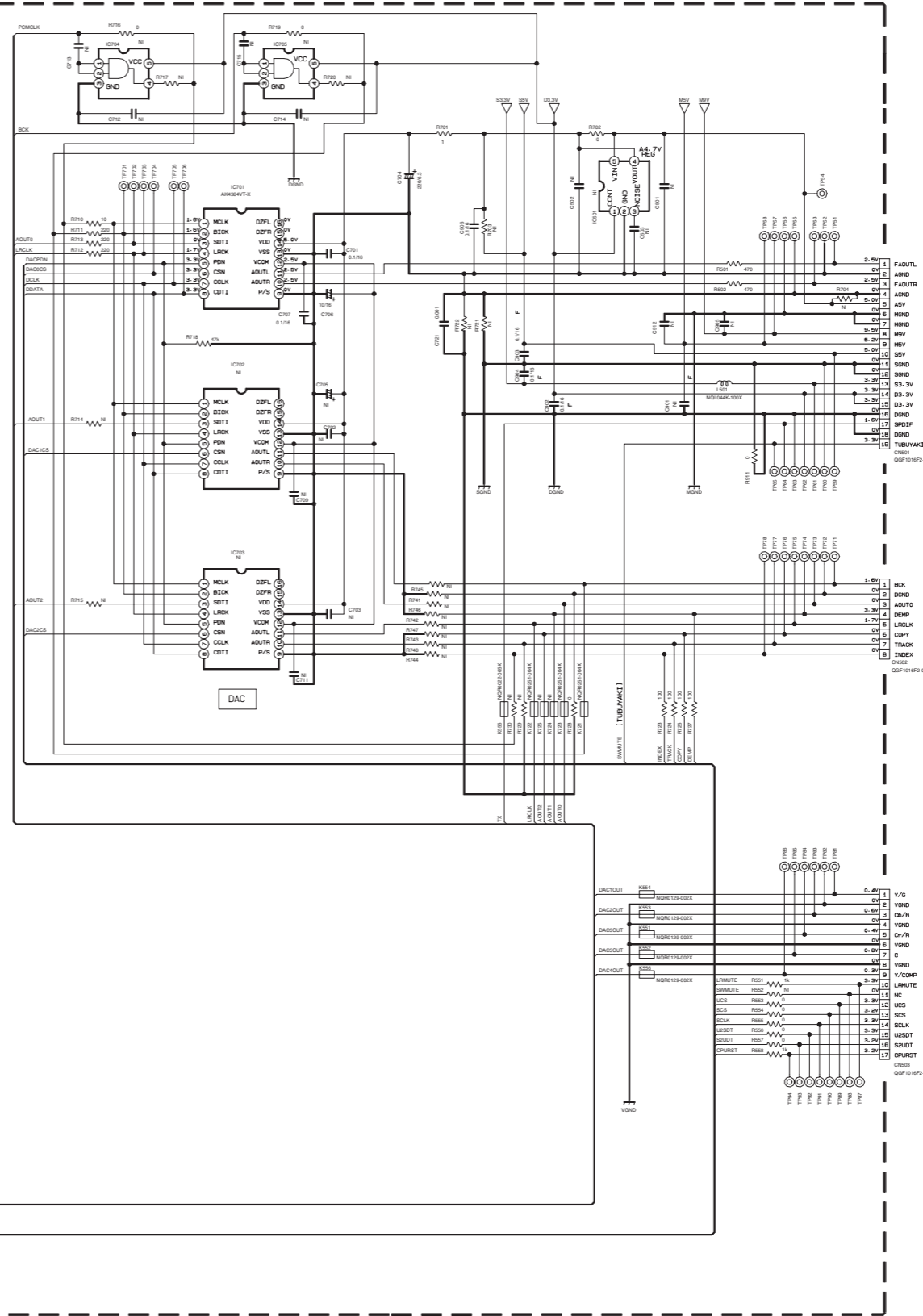

FROM CH220 OF GVA10060-A1(1/2)

TO CN720 OF GVA10060-A1(2/2)

(SHEET 3)

(SHEET 4)

NOTES

- VOLTAGES ARE DC-MEASURED WITH A DIGITAL VOLT METER WITHOUT INPUT SIGNAL. CONDITION: DVD DISC IN. MODE: DVD STOP
- UNLESS OTHERWISE SPECIFIED. ALL RESISTORS ARE 1/10W ±5% METAL GLAZE RESISTOR. OR 0.5X METAL GLAZE RESISTOR. ALL CAPACITORS ARE 50V OF 50V CERAMIC CAPACITOR. ALL RESISTANCE VALUES ARE IN OHM(Ω). ALL CAPACITANCE VALUES ARE IN μF(μF). ALL E-CAPACITORS ARE SHOWN IN THE FORM OF CAPACITANCE(μF)/RATED VOLTAGE (V). ALL INDUCTANCE VALUES ARE IN μH(μH).
- NI STANDS FOR NOT INSERTED PARTS.
- DIGITAL TRANSISTOR

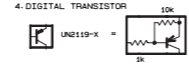

Printed circuit boards

■ Main board

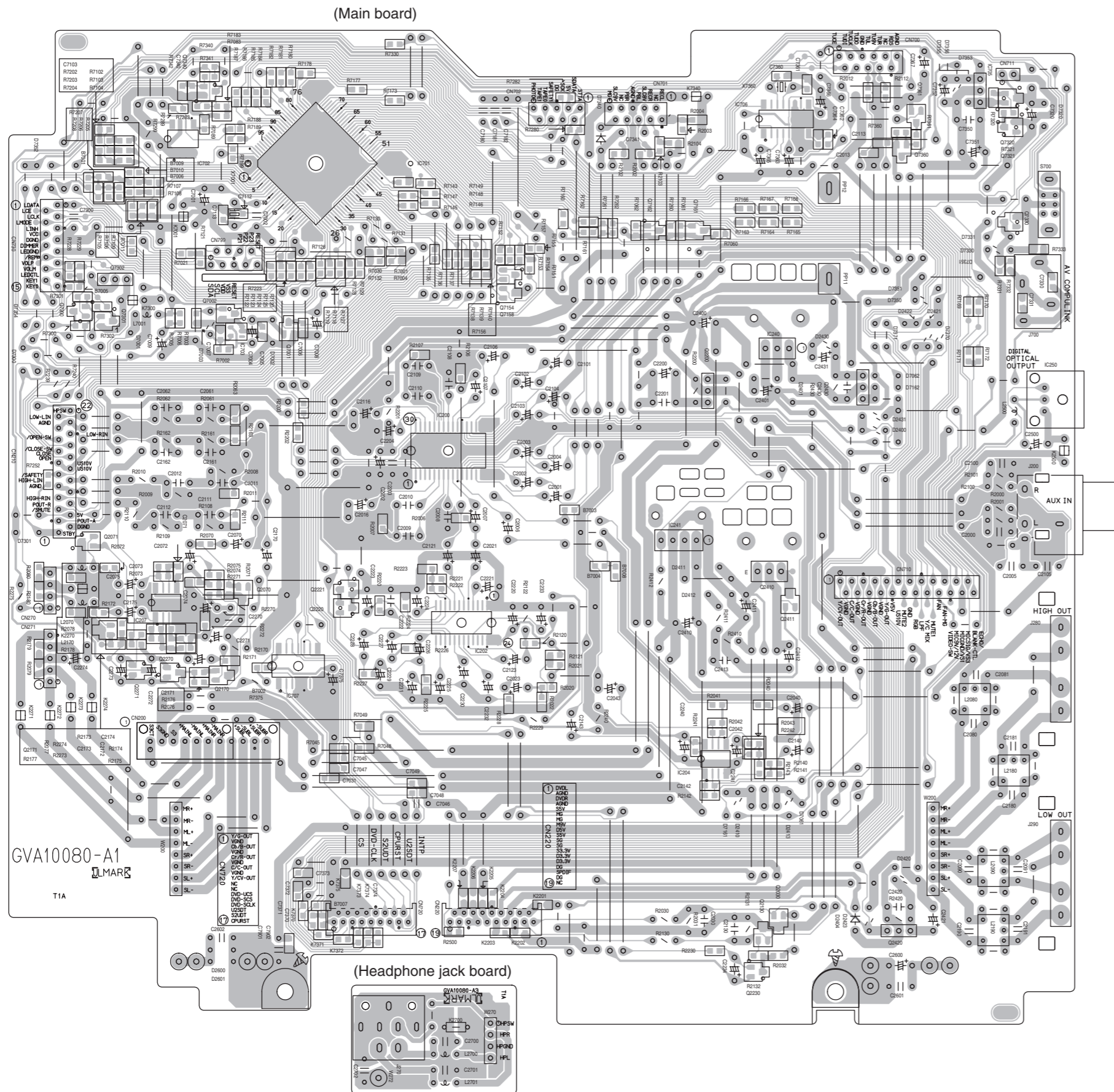

■ Video board

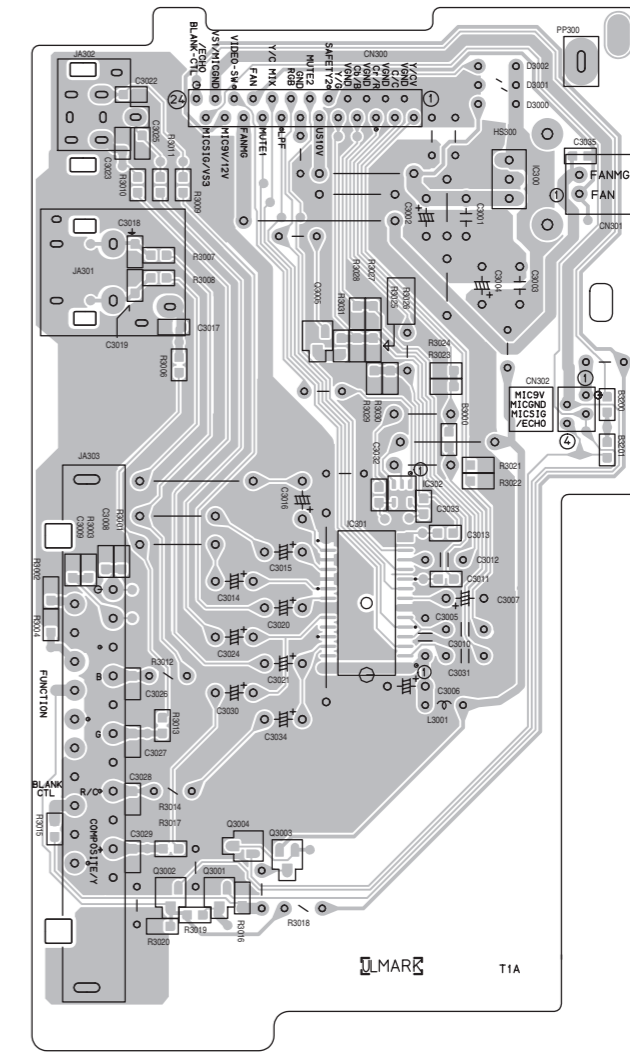

■ Power board

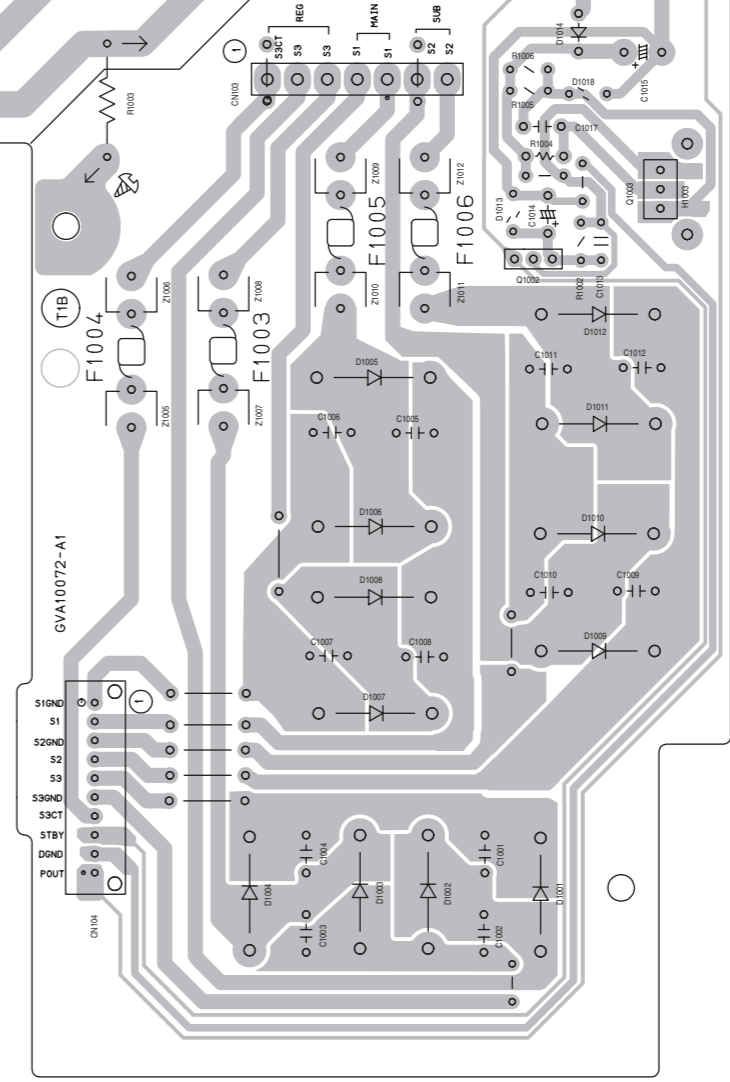
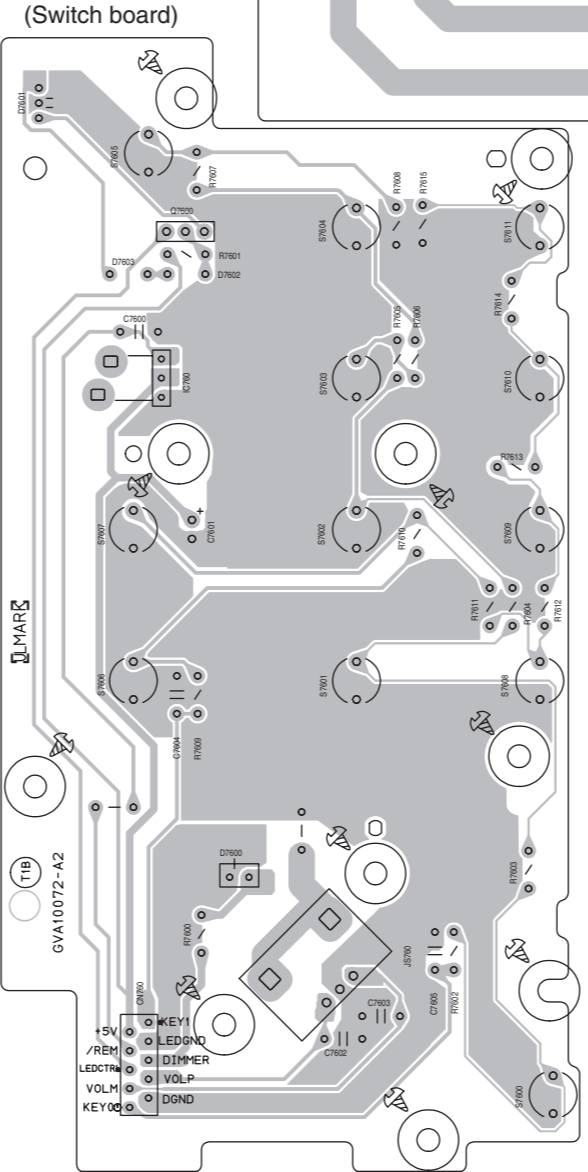
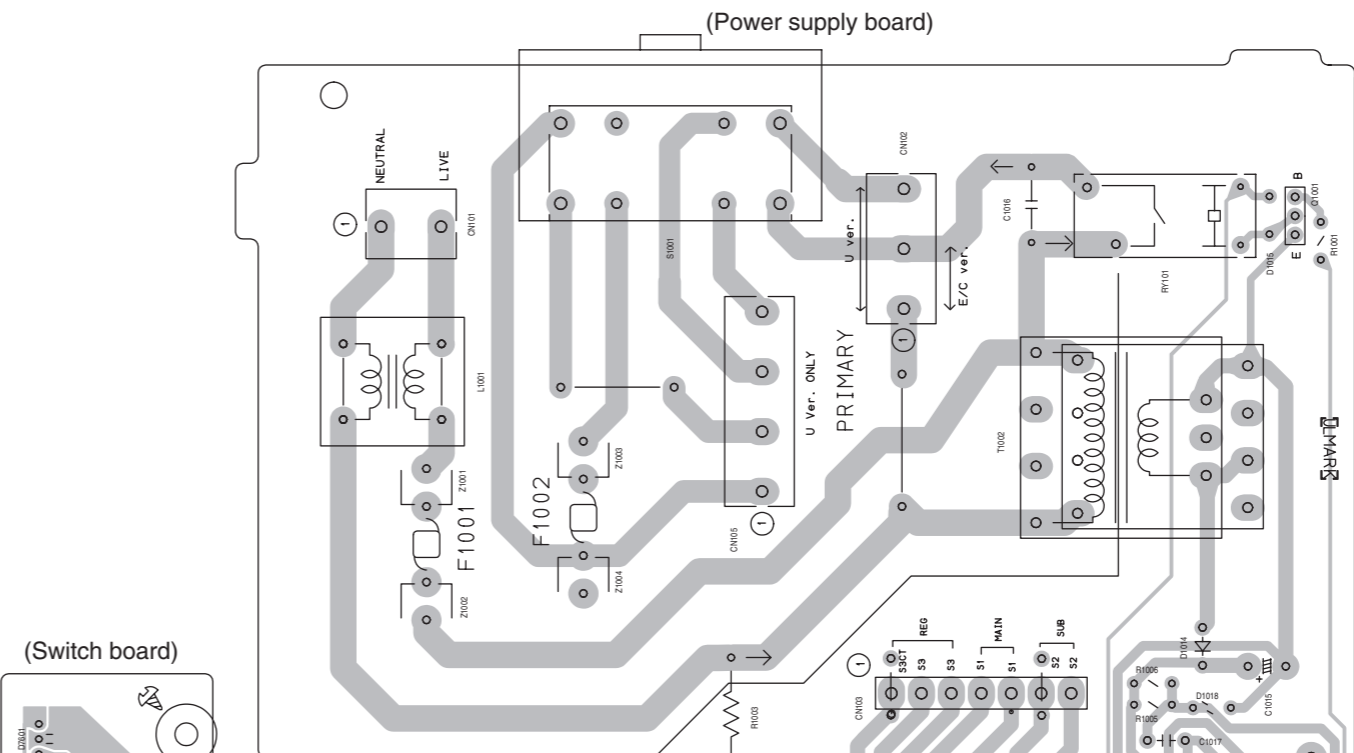
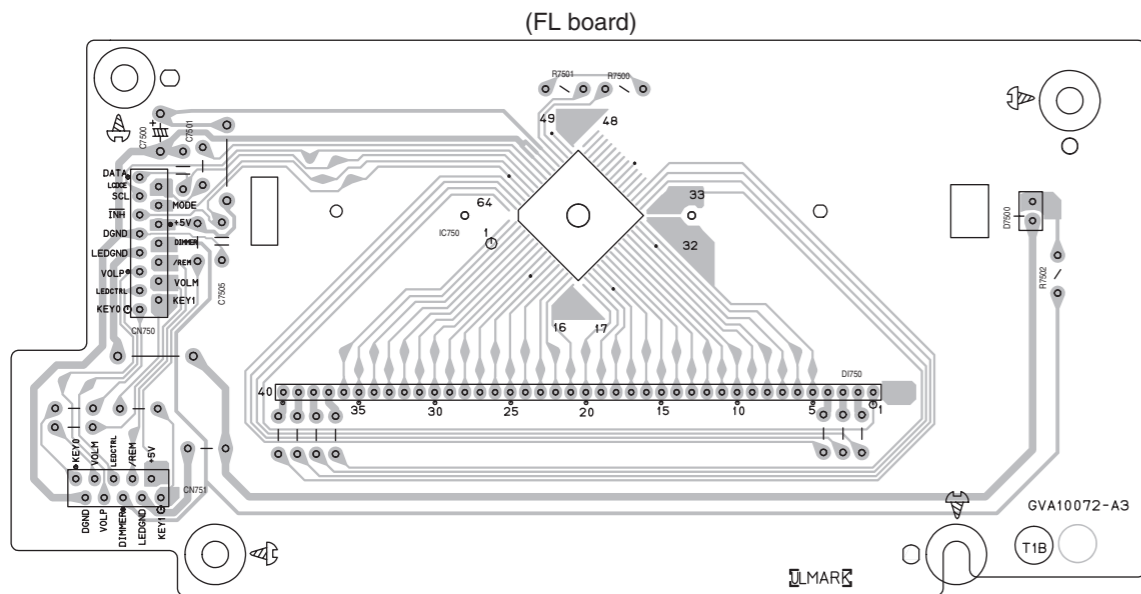
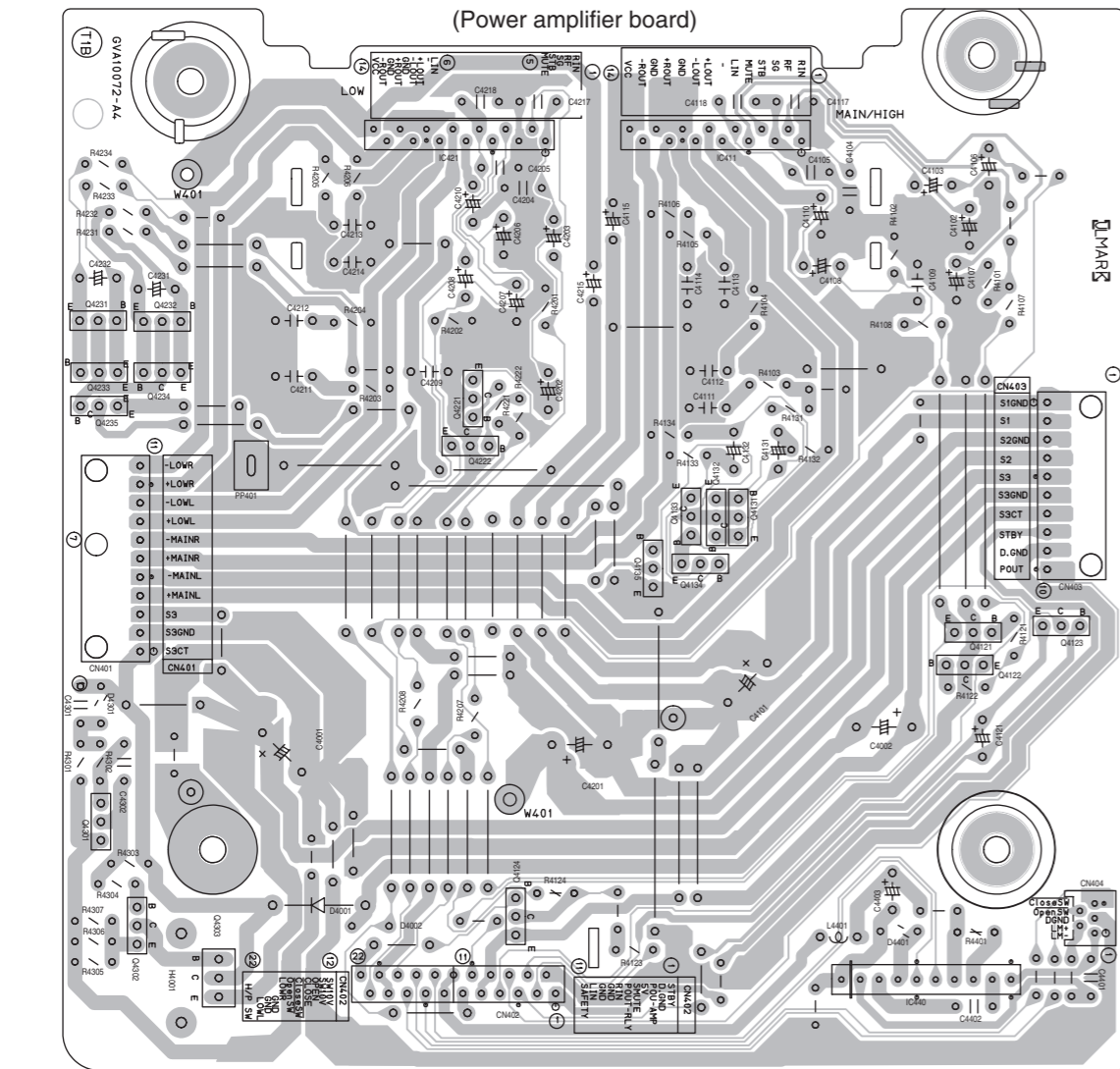

■ DVD servo board

Forward side

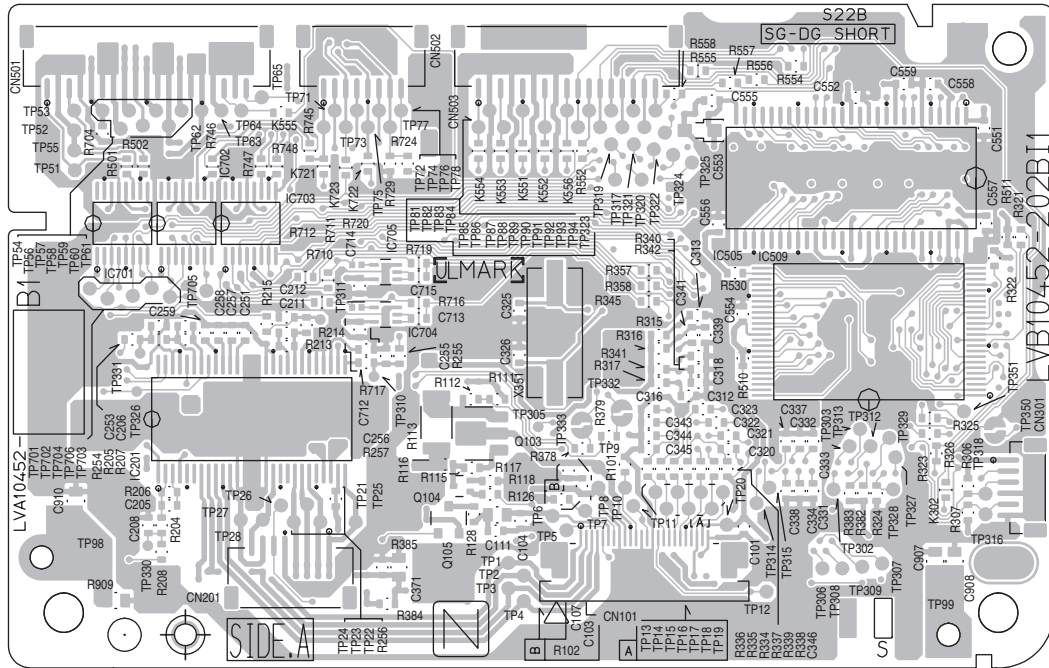

Reverse side

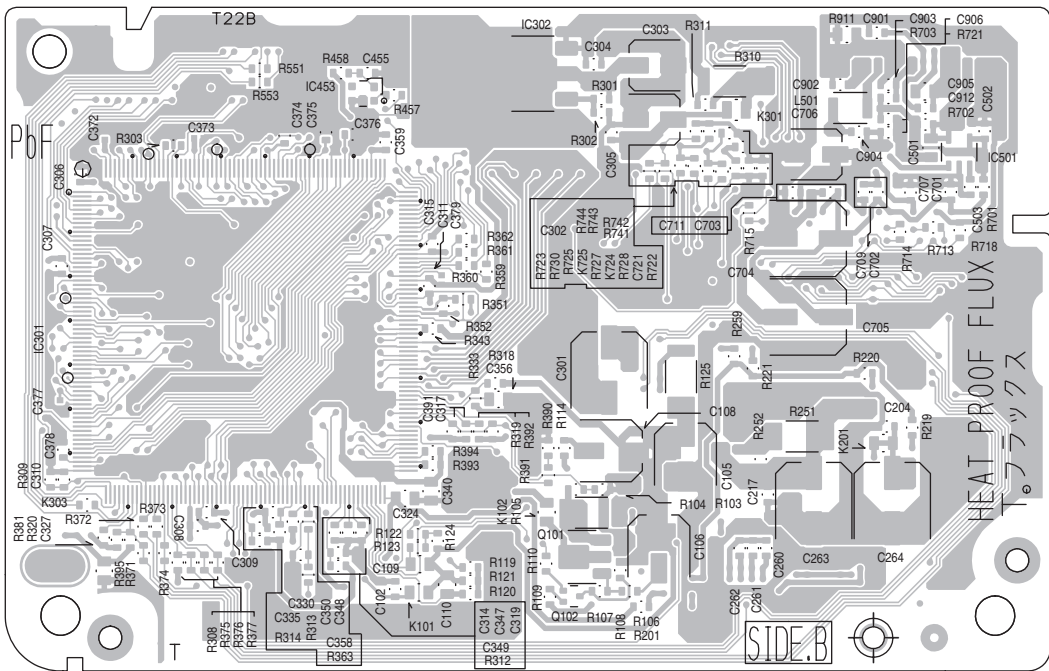

■ Switch board

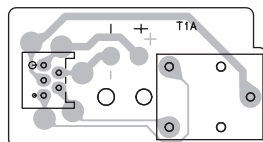

JVC

Victor Company of Japan, Limited

AV & MULTIMEDIA COMPANY AUDIO/VIDEO SYSTEMS CATEGORY 10-1, 1chome, Ohwatari-machi, Maebashi-city, 371-8543, Japan

(No.MB229SCH)



Printed in Japan
WPC